



AMPHENOL PCD SHENZHEN



LVRC

Low voltage rectangular connector

www.amphenolpcd.com.cn

HIGHPOWER @ AMPHENOL
TRUSTED GLOBALLY

PRODUCT INTRODUCTION	2
LVRC 26 PIN	3
PLUG	4
SOCKET	5
HOW TO ORDER	7
LVRC 35 PIN	8
PLUG	9
SOCKET	10
HOW TO ORDER	12
LVRCK 35 PIN	13
PLUG	14
SOCKET	15
HOW TO ORDER	17
HVRC 12 PIN	18
PLUG	19
SOCKET	20
HOW TO ORDER	22



Low Voltage Rectangular Connectors light weight, multiple coding positions, 26 & 35 position low voltage available, also we provide 12 position high voltage connectors are designed to meet USCAR-2, USCAR-37 specifications. With a current carrying up to 13A, 250V and 12 position up to 800V, the LVRC connectors can be used in many hybrid and electric vehicle device applications.

Receptacle can be front or rear mounted.



KEY FEATURES

Easy to install, reliable connection

Multiple coding positions

Contacts can be remove and replace by tools

Sealing, IP67 mated

Economical

MECHANICAL	
Durability	100 mating cycles max
Wire range	Power: 18 to 14 AWG Wire insulation OD: 2.2 to 3.0 mm Signal: 22 to 18 AWG Wire insulation OD: 1.35 to 2.5 mm
Connection type	Crimping
ELECTRICAL	
Rated current	Power: 13A Signal: 5A
Rated voltage	250V AC / 300V DC
Insulator resistance	≥ 100mΩ (500V DC)
Temperature rise	≤ 55K
ENVIRONMENTAL	
Temperature range	-40°C to 125°C
Humidity	90% to 95%
Sealing	IP67 (mated)
Inflammability	UL94-V0
STANDARDS	
USCAR-2	
USCAR-37	
RoHS	
MATERIAL	
Housing	PA66
Contacts	Copper alloy, tin plating
Insert	Silicone

PLUG

26 PIN PLUG

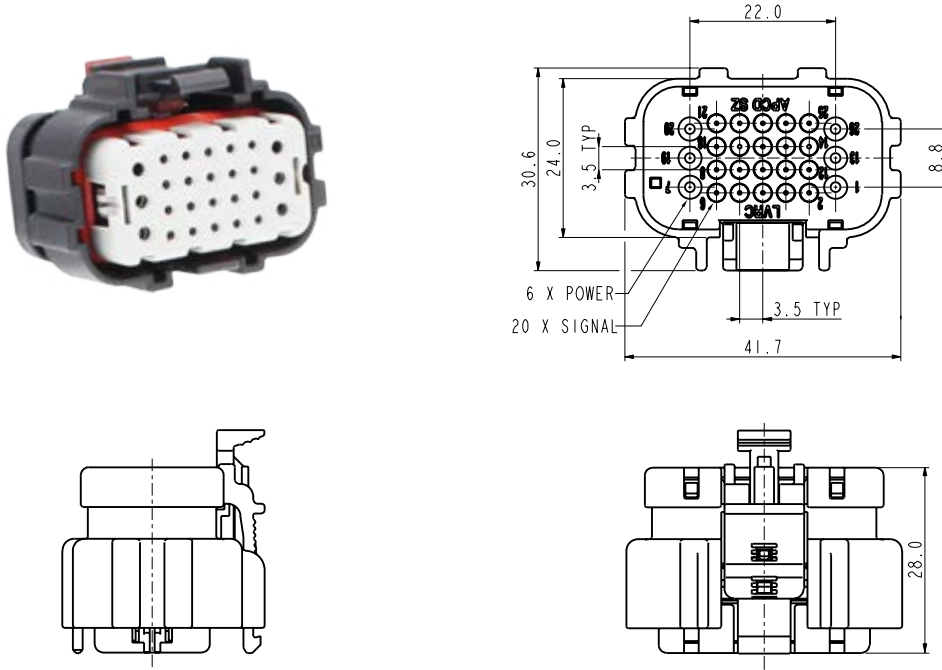

CONTACTS

All connectors do not include contacts. Please order them separately (ref: P/N below)

CONTACTS (Female contact)			
POWER (Female contact)	SIGNAL (Female contact)	SEAL (POWER)	SEAL (SIGNAL)
P/N: LVRC16PC01S	P/N: LVRC20PC01S	P/N: LVRC16LP	P/N: LVRC20LP

INSERT ORIENTATIONS

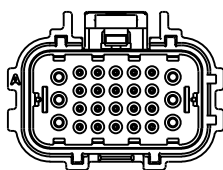

Coding A
LVRCF26PCA

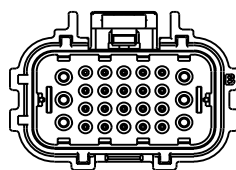

Coding B
LVRCF26PCB

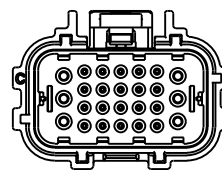

Coding C
LVRCF26PCC

P/N

26 PIN SOCKET

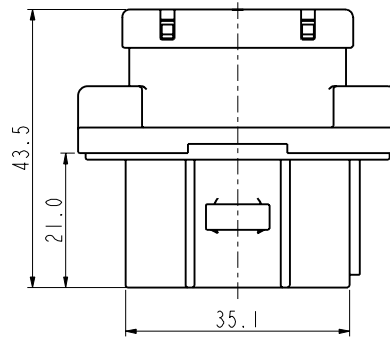
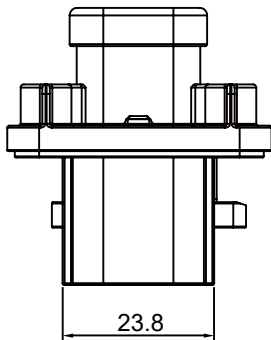
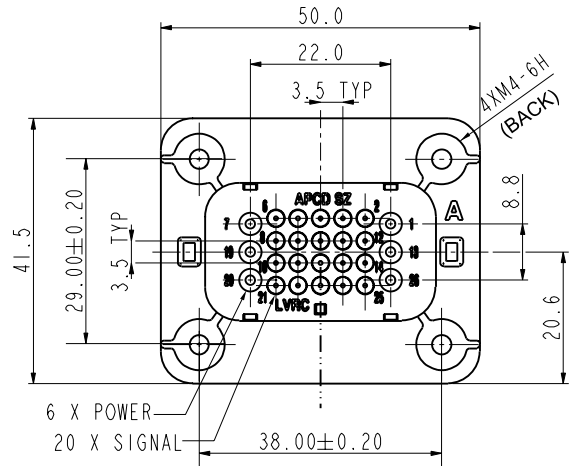

CONTACTS

All connectors do not include contacts. Please order them separately (ref: P/N below)

CONTACTS (Male contact)

POWER (Male contact)	SIGNAL (Male contact)	SEAL (POWER)	SEAL (SIGNAL)
P/N: LVRC16SC01S	P/N: LVRC20SC01S	P/N: LVRC16LP	P/N: LVRC20LP

SOCKET

PANEL MOUNTING DIMENSION

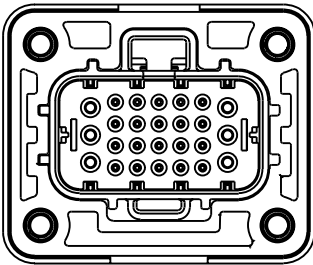
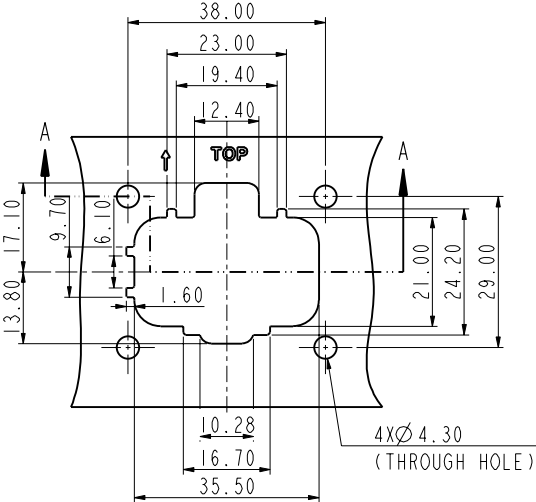
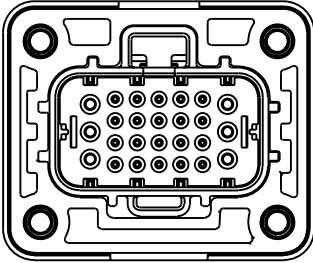
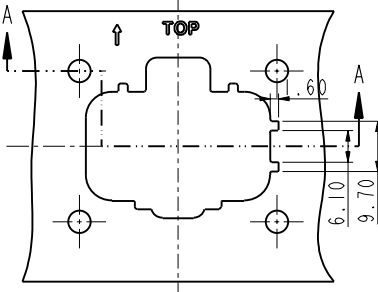
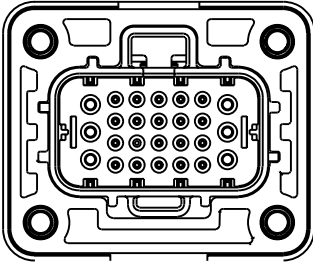
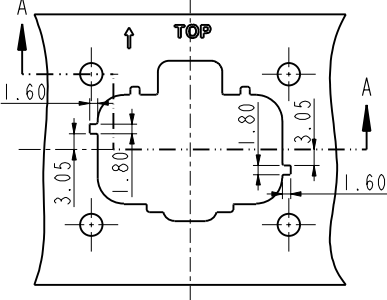
PART NUMBER	INSERT ORIENTATIONS	PANEL MOUNTING DIMENSION
LVRCM26SCRA	 <p data-bbox="655 965 762 999">Coding A</p>	
LVRCM26SCRB	 <p data-bbox="655 1473 762 1507">Coding B</p>	
LVRCM26SCRC	 <p data-bbox="655 1892 762 1926">Coding C</p>	

HOW TO ORDER

PLUG

	LVRC	F	26	P	C	A
Contact type:						
F: Female contact						
Number of contacts: 26						
Connector type:						
P: Plug						
Connection type:						
C: Crimping						
Coding / Alternate position:						
A: Coding A						
B: Coding B						
C: Coding C						

SOCKET

	LVRC	M	26	S	C	R	A
Contact type:							
M: Male contact							
Number of contacts: 26							
Connector type:							
S: Socket							
Connection type:							
C: Crimping							
Socket mounting type:							
R: Rear mounted							
Coding / Alternate position:							
A: Coding A							
B: Coding B							
C: Coding C							

LVRC 35 PIN



KEY FEATURES

Easy to install, reliable connection

Multiple coding positions

Receptacle available in front or rear mounted

Contacts can be remove and replace by tools

Sealing, IP67 mated

Economical

MECHANICAL	
Durability	50 mating cycles max
Wire range	22 to 14 AWG Wire insulation OD: 1.7 to 2.7 mm
Connection type	Crimping
ELECTRICAL	
Rated current	8A (22 to 16 AWG) 13A (14 AWG, 6POS LOADED, MAX)
Rated voltage	250V AC
Insulator resistance	≥ 100mΩ (500V DC)
Temperature rise	≤ 55K
ENVIRONMENTAL	
Temperature range	-40°C to 125°C
Humidity	90% to 95%
Sealing	IP67 (mated)
Inflammability	UL94-V0
STANDARDS	
USCAR-2	
USCAR-37	
RoHS	
MATERIAL	
Housing	PA66
Contacts	Copper alloy, tin plating
Insert	Silicone

35 PIN PLUG

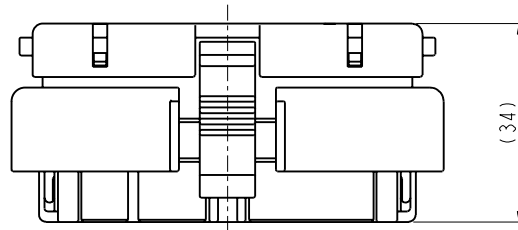
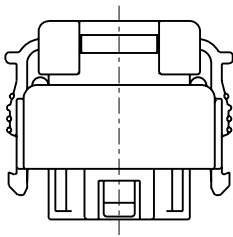
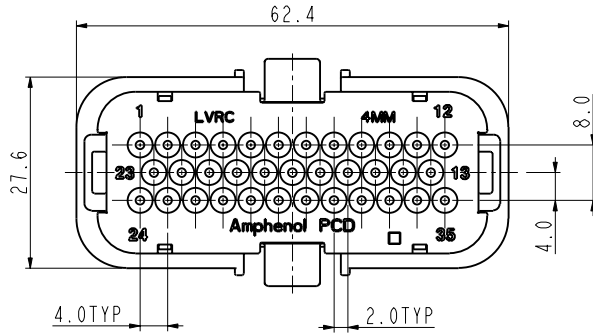

CONTACTS

All connectors do not include contacts. Please order them separately (ref: P/N below)	
CONTACTS (Female contact)	
Female contact	Sealing plug
P/N: C310023101	P/N: C220011207

SOCKET

35 PIN SOCKET: FRONT MOUNTED

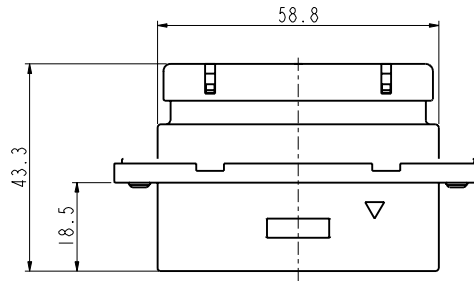
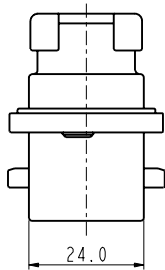
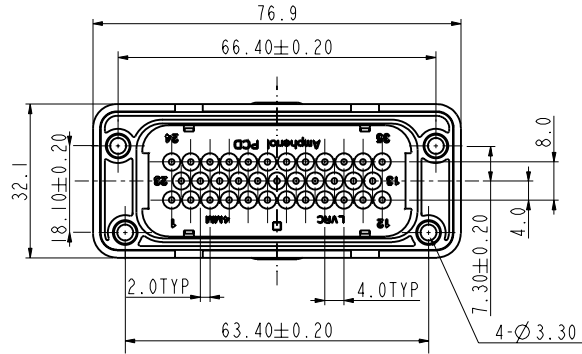

CONTACTS

All connectors do not include contacts. Please order them separately (ref: P/N below)

CONTACTS (Male contact)

Male contact	Sealing plug
P/N: C310023102	P/N: C220011207

PANEL MOUNTING DIMENSION

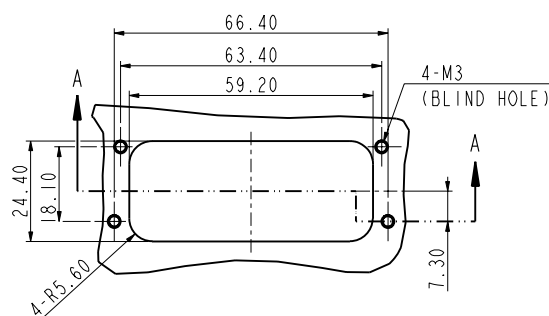

35 PIN SOCKET: REAR MOUNTED

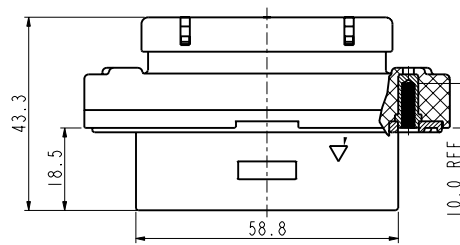
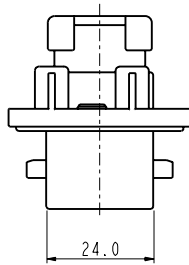
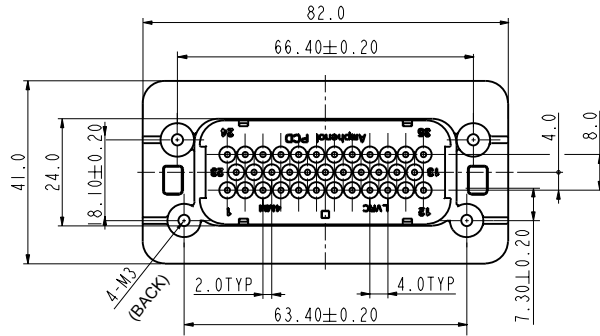

CONTACTS

All connectors do not include contacts. Please order them separately (ref: P/N below)

CONTACTS (Male contact)

Male contact	Sealing plug
P/N: C310023102	C220011207

PANEL MOUNTING DIMENSION

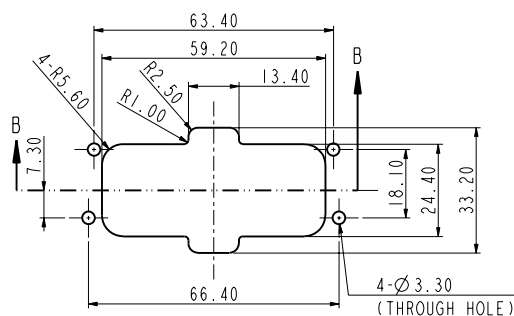

HOW TO ORDER

HOW TO ORDER

PLUG

	LVRC	F	35	P	C
Contact type: F: Female contact					
Number of contacts: 35					
Connector type: P: Plug					
Connection type: C: Crimping					

SOCKET

	LVRC	M	35	S	C	F
Contact type: M: Male contact						
Number of contacts: 35						
Connector type: S: Socket						
Connection type: C: Crimping						
Socket mounting type: F: Front mounted R: Rear mounted						



KEY FEATURES

Easy to install, reliable connection

Multiple coding positions

Contacts can be remove and replace by tools

Sealing, IP67 mated

Economical

MECHANICAL	
Durability	50 mating cycles max
Wire range	22 to 18 AWG Wire insulation OD: 1.35 to 2.5 mm
Connection type	Crimping
ELECTRICAL	
Rated current	5A
Rated voltage	250V AC / 300V DC
Insulator resistance	≥ 100mΩ (500V DC)
Temperature rise	≤ 55K
ENVIRONMENTAL	
Temperature range	-40°C to 125°C
Humidity	90% to 95%
Sealing	IP67 (mated)
Inflammability	UL94-V0
STANDARDS	
USCAR-2	
USCAR-37	
RoHS	
MATERIAL	
Housing	PA66
Contacts	Copper alloy, tin plating
Insert	Silicone

PLUG

35 PIN PLUG

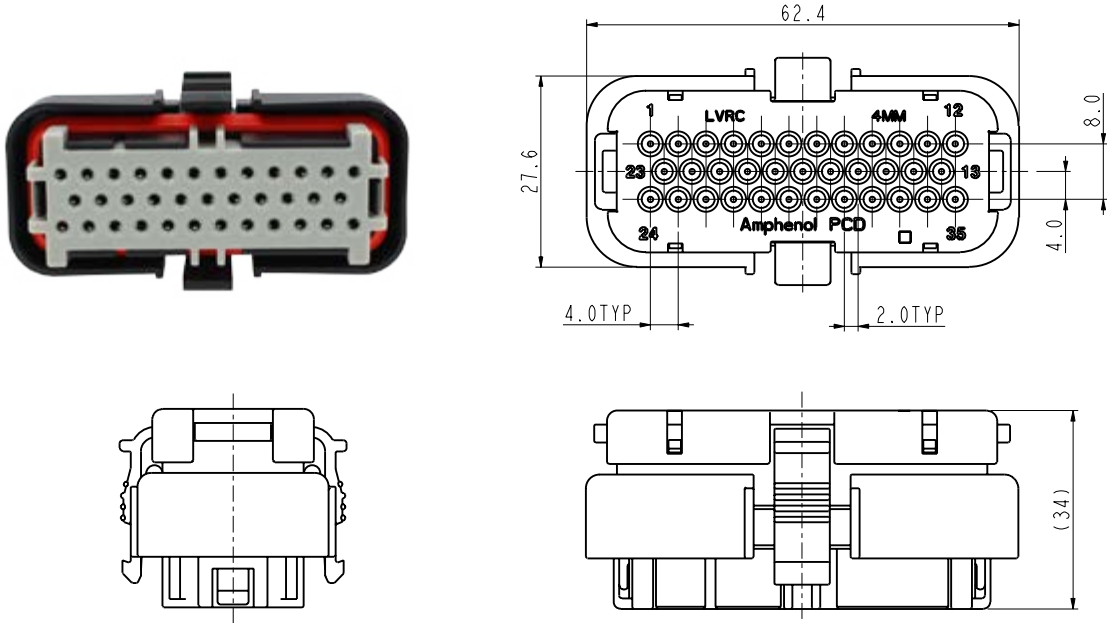

CONTACTS

All connectors do not include contacts. Please order them separately (ref: P/N below)

CONTACTS (Female contact)	
Female contact	Sealing plug
P/N: C310023101	P/N: C220011207

PANEL MOUNTING DIMENSION

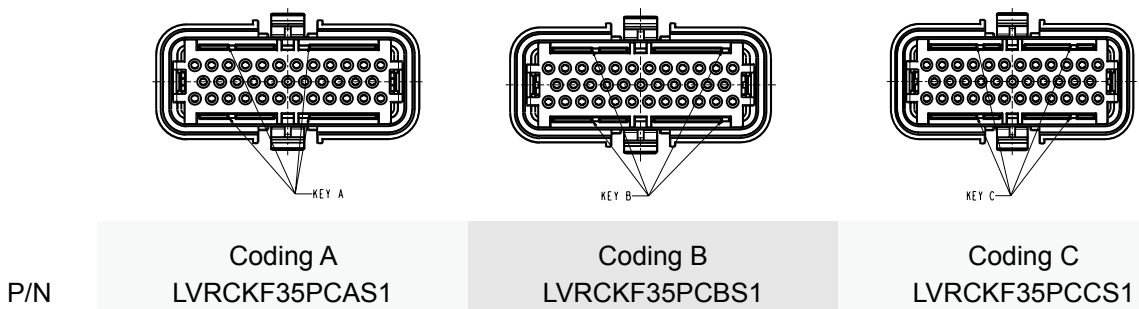

35 PIN SOCKET

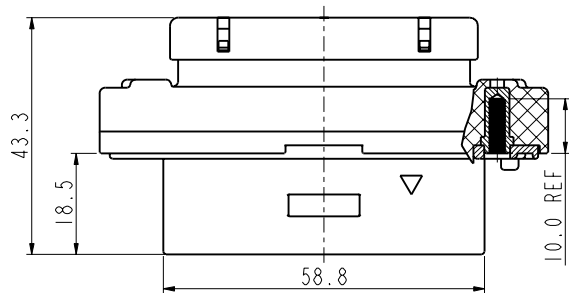
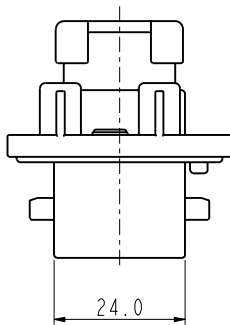
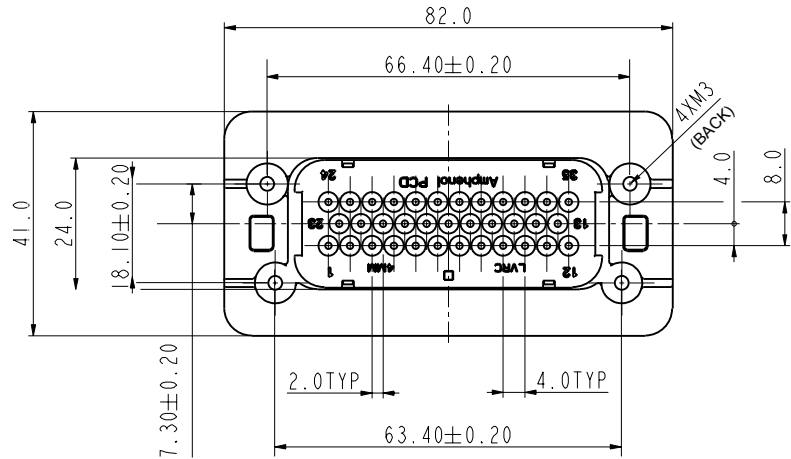

CONTACTS

All connectors do not include contacts. Please order them separately (ref: P/N below)

CONTACTS (Male contact)

Male contact	Sealing plug
P/N: C310023102	P/N: C220011207

SOCKET

PANEL MOUNTING DIMENSION

PART NUMBER	INSERT ORIENTATIONS	PANEL MOUNTING DIMENSION
LVRCKM35SCRAS1		
LVRCKM35SCRBS1		
LVRCKM35SCRCS1		

HOW TO ORDER

PLUG

	LVRCK	F	35	P	C	A	S1
Contact type:		F: Female contact					
Number of contacts:		35					
Connector type:		P: Plug					
Connection type:		C: Crimping					
Coding / Alternate position:		A: Coding A B: Coding B C: Coding C					

SOCKET

	LVRCK	M	35	S	C	R	A	S1
Contact type:		M: Male contact						
Number of contacts:		35						
Connector type:		S: Socket						
Connection type:		C: Crimping						
Socket mounting type:		R: Rear mounted						
Coding / Alternate position:		A: Coding A B: Coding B C: Coding C						

HVRC 12 PIN



KEY FEATURES

Easy to install, reliable connection

Multiple coding positions

Contacts can be remove and replace by tools

Sealing, IP67 mated

Economical

MECHANICAL	
Durability	50 mating cycles max
Wire range	22 to 18 AWG Wire insulation OD: 1.35 to 2.5 mm
Connection type	Crimping
ELECTRICAL	
Rated current	5A
Rated voltage	800V AC
Insulator resistance	≥ 100mΩ (500V DC)
Temperature rise	≤ 55K
ENVIRONMENTAL	
Temperature range	-40°C to 125°C
Humidity	90% to 95%
Sealing	IP67 (mated)
Inflammability	UL94-V0
STANDARDS	
USCAR-2	
USCAR-37	
RoHS	
MATERIAL	
Housing	PA66
Contacts	Copper alloy, tin plating
Insert	Silicone

12 PIN PLUG

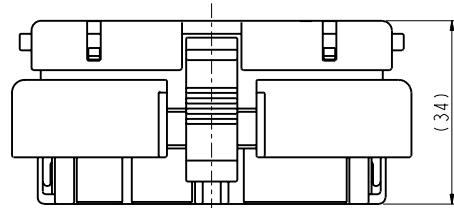
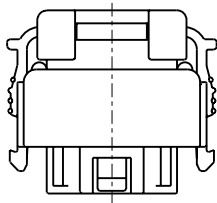
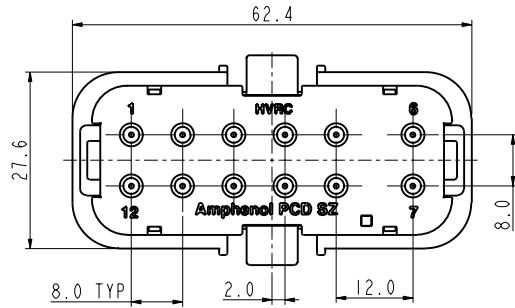
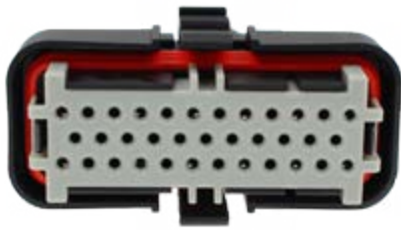

CONTACTS

All connectors do not include contacts. Please order them separately (ref: P/N below)

CONTACTS (Female contact)	
Female contact	Sealing plug
P/N: C310023101	P/N: C220011207

PANEL MOUNTING DIMENSION

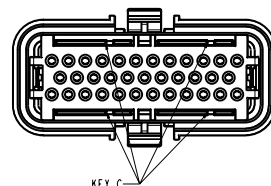
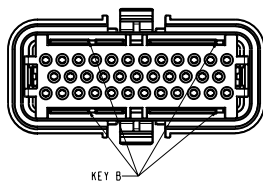
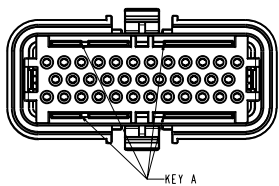

P/N

Coding A
HVRFCF12PCA

Coding B
HVRFCF12PCB

Coding C
HVRFCF12PCC

SOCKET

12 PIN SOCKET

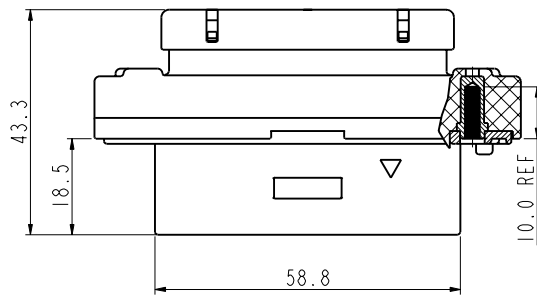
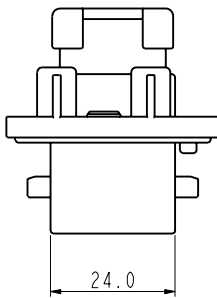
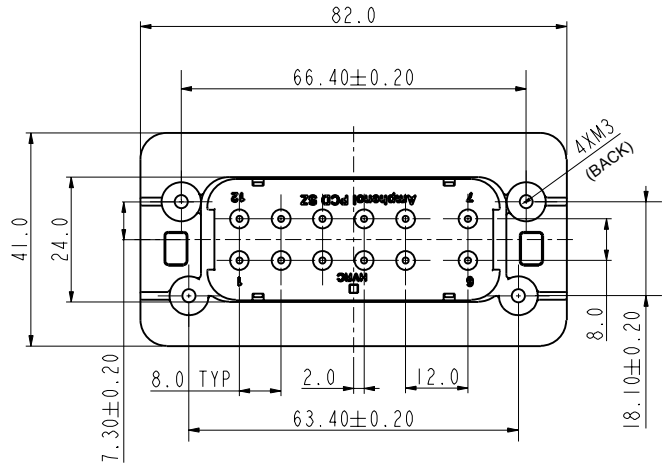

CONTACTS

All connectors do not include contacts. Please order them separately (ref: P/N below)

CONTACTS (Male contact)

Male contact	Sealing plug
P/N: C310023102	P/N: C220011207

PANEL MOUNTING DIMENSION

PART NUMBER	INSERT ORIENTATIONS	PANEL MOUNTING DIMENSION
HVRCM12SCRA		
HVRCM12SCRB		
HVRCM12SCRC		

HOW TO ORDER

HOW TO ORDER

PLUG

	HVRC	F	12	P	C	A	S1
Contact type: F: Female contact							
Number of contacts: 12							
Connector type: P: Plug							
Connection type: C: Crimping							
Coding / Alternate position: A: Coding A B: Coding B C: Coding C							
Version							

SOCKET

	HVRC	M	12	S	C	R	A	S1
Contact type: M: Male contact								
Number of contacts: 12								
Connector type: S: Socket								
Connection type: C: Crimping								
Socket mounting type: R: Rear mounted								
Coding / Alternate position: A: Coding A B: Coding B C: Coding C								
Version								

Amphenol PCD Shenzhen

Building C
Da Gang Industrial Zone, Yu Tang Street
Guang Ming District Shenzhen 518132
China

Tel.: +86 755-8173-8000
Email: inquiry@amphenolpcd.com.cn

www.amphenolpcd.com.cn

Notes:

Amphenol PCD Shenzhen has made every effort to ensure that the information contained in this catalog is accurate at the time of publication. Specifications or information stated in this publication are subject to change without notice.

Amphenol PCD Shenzhen reserves the right to clarify this catalog.